

HPI - 6FER2

The HPI - 6FER2 is a high - output, high - speed silicon photodiode mounted in a side - viewing plastic package with visible light cutoff filter. This photodiode is both compact and easy to mount.

FEATURES

- Compact visible ray cut off mold type
- High speed response

APPLICATIONS

- Optical transmission
- Optic receiver modules

DIMENSIONS

(Unit : mm)

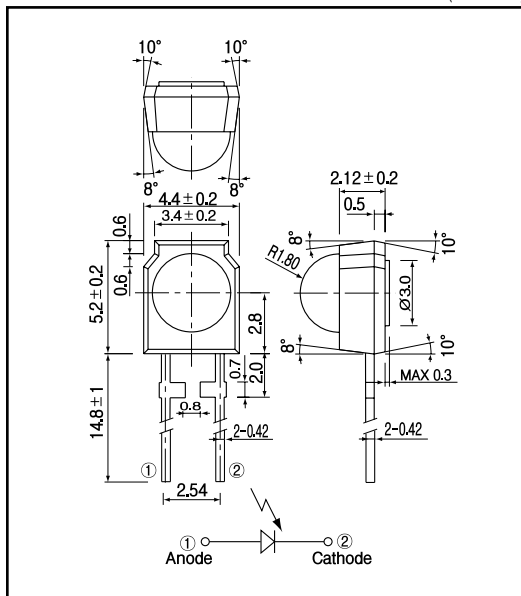

MAXIMUM RATINGS

(Ta=25)

Item	Symbol	Rating	Unit
Reverse voltage	V_R	35	V
Power dissipation	P_b	150	mW
Operating temp.	$T_{opr.}$	- 30 + 70	
Storage temp.	$T_{stg.}$	- 40 + 80	
Soldering temp.*1	$T_{sol.}$	260	

*1.For MAX.5 seconds at the position of 2 mm from the package

ELECTRO-OPTICAL CHARACTERISTICS

(Ta=25)

Item	Symbol	Conditions	Min.	Typ.	Max.	Unit.
Open circuit voltage	V_{oc}	$E_v = 1,000lx^2$		0.38		V
Short circuit current	I_{sc}	$E_v = 1,000lx^2$		56		μA
Curve factor	C.F.		0.55			—
Dark current	I_d	$V_R = 10V$			100	nA
Capacitance	C_t	$V = 0V, f = 1MHz$		48		pF
Temperature coefficient of V_{oc}	t			- 2.2		mV/
Temperature coefficient of I_{sc}	t			0.18		%/
Spectral sensitivity				700 1100		nm
Peak wavelength	ρ			1000		nm
Half angle				± 50		deg.

*2.Color temp.=2856K standard Tungsten lamp

PIN Photodiode

HPI - 6FER2

Light current Vs. Forward voltage

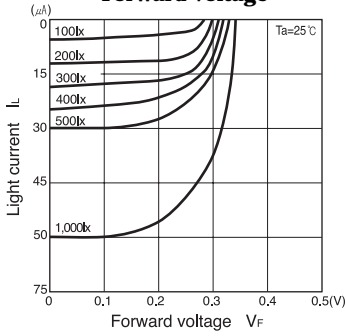

Short circuit current Vs. Illuminance

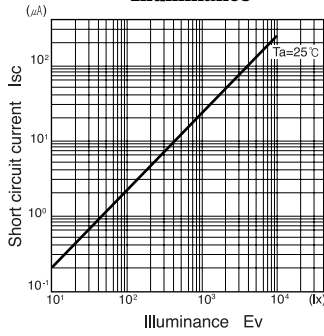

Dark current Vs. Ambient temperature

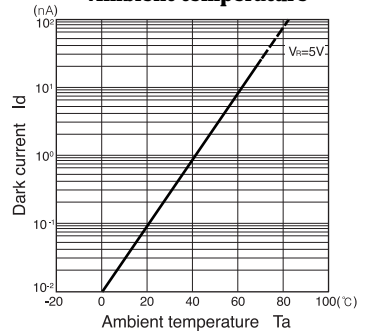

Relative sensitivity Vs. Wavelength

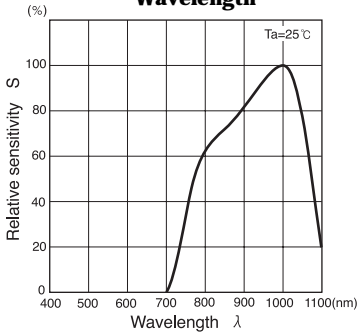

Dark current Vs. Reverse voltage

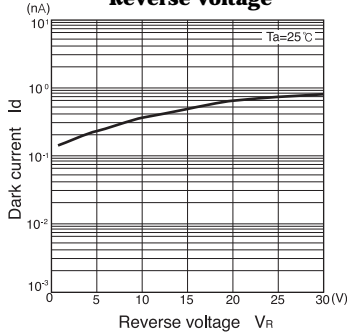

Radiant Pattern

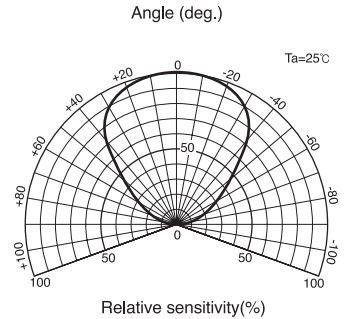

Capacitance between terminals Vs. Reverse voltage

