

IR Receiver for High Data Rate PCM at 455 kHz

Description

The TSOP5700 is a miniaturized SMD IR receiver for infrared remote control and IR data transmission. PIN diode and preamplifier are assembled on lead frame, the epoxy package is designed as IR filter.

The demodulated output signal can directly be decoded by a microprocessor. The main benefit is the operation with high data rates and long distances.

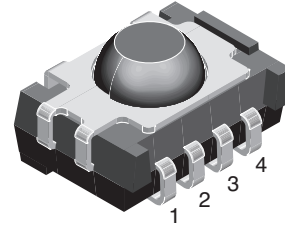

16797

Features

- Photo detector and preamplifier in one package
- Internal Bandfilter for PCM frequency
- Internal shielding against electrical field disturbance
- TTL and CMOS compatibility
- Output active low
- Small size package



Special Features

- Data rate 20 kbit/s
- Supply voltage 2.7 - 5.5 V
- Short settling time after power on
- High envelope duty cycle can be received
- Enhanced immunity against disturbance from energy saving lamps
- Taping available for topview and sideview assembly

Mechanical Data

Pinning:

1 = GND, 2 = NC, 3 = OUT, 4 = V_S

Block Diagram

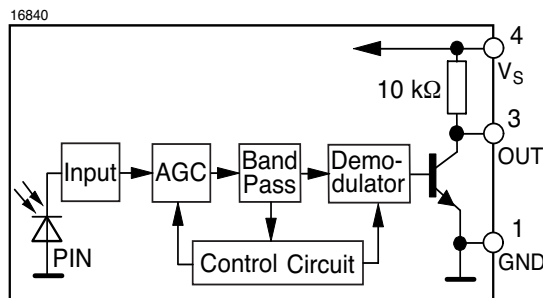

Application Circuit

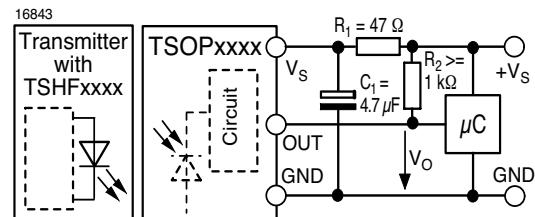

R₁ + C₁ recommended to suppress power supply disturbances.

R₂ optional for improved pulse forming.

Absolute Maximum Ratings

Absolute Maximum Ratings

$T_{amb} = 25\text{ }^{\circ}\text{C}$, unless otherwise specified

Parameter	Test condition	Symbol	Value	Unit
Supply Voltage	Pin 4	V_S	- 0.3 to + 6.0	V
Voltage at output to supply	Pin 3	$V_S - V_O$	- 0.3 to ($V_S + 0.3$)	V
Supply Current	Pin 4	I_S	5	mA
Output Voltage	Pin 3	V_O	- 0.3 to + 6.0	V
Output Current	Pin 3	I_O	15	mA
Junction Temperature		T_j	100	$^{\circ}\text{C}$
Storage Temperature Range		T_{stg}	- 40 to + 85	$^{\circ}\text{C}$
Operating Temperature Range		T_{amb}	- 25 to + 85	$^{\circ}\text{C}$
Power Consumption	$T_{amb} \leq 85\text{ }^{\circ}\text{C}$	P_{tot}	50	mW

Electrical and Optical Characteristics

$T_{amb} = 25\text{ }^{\circ}\text{C}$, unless otherwise specified

Parameter	Test condition	Symbol	Min	Typ.	Max	Unit
Supply Current (Pin 4)	Dark ambient	I_{SD}		2.0	2.7	mA
	$E_v = 40\text{ klx}$, sunlight	I_{SH}		2.3		mA
Supply Voltage (Pin 4)		V_S	2.7	5	5.5	V
Transmission Distance	$\lambda_p = 870\text{ nm}$, IR Diode TSHF5400, $I_F = 300\text{ mA}$	d_{max}		15		m
	$\lambda_p = 950\text{ nm}$, IR Diode TSAL6400, $I_F = 300\text{ mA}$	d_{max}		9		m
Threshold Irradiance	$\lambda_p = 870\text{ nm}$, optical test signal of Fig.1	$E_{e\ min}$		1.5	2.5	mW/m^2
Maximum Irradiance	Optical test signal of Fig.1	$E_{e\ max}$	30			W/m^2
Output Voltage Low (Pin 3)	1 k Ω external pull up resistor	V_{QL}			100	mV
Output Voltage High (Pin 3)	No external pull-up resistor, test signal see fig. 1	V_{QH}	$V_S - 0.25$			V
Bandpass filter quality		Q		10		
Out-Pulse width tolerance	Optical test signal of Fig.1, $2.5\text{ mW}/\text{m}^2 \leq E_e \leq 30\text{ W}/\text{m}^2$	Δ_{tpo}	- 15	+ 5	+ 15	μs
Delay time of output pulse	Optical test signal of Fig.1, $E_e > 2.5\text{ mW}/\text{m}^2$	t_{don}	15		36	μs
Receiver start up time	Valid data after power on	t_v		50		μs
Falling time	Leading edge of output pulse	t_f		0.4		μs
Rise time	No external pull up resistor	t_r		12		μs
	1 k Ω external pull up resistor	t_r		1.2		μs
Directivity	Angle of half transmission distance	$\phi_{1/2}$		± 50		deg

Typical Characteristics (Tamb = 25 °C unless otherwise specified)

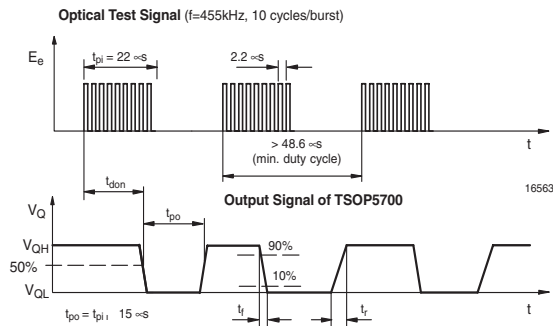

Figure 1. Output Function

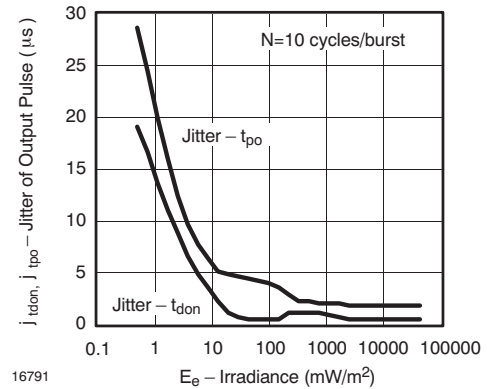

Figure 4. Jitter of Output Pulse

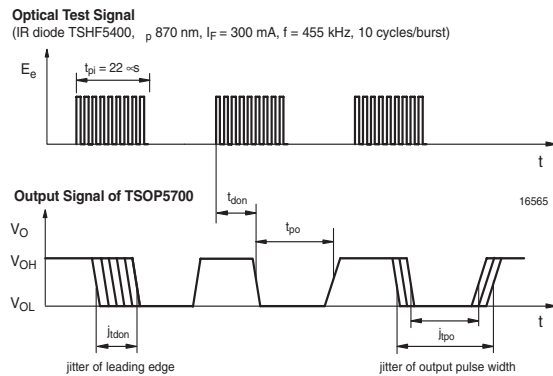

Figure 2. Output Function (mit Jitter)

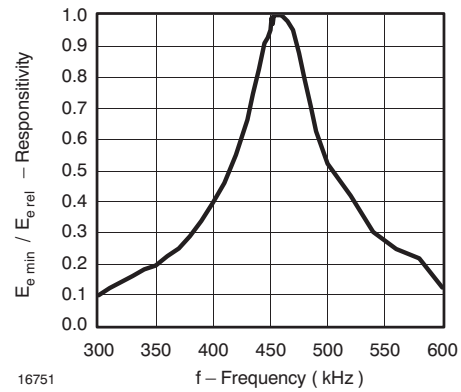

Figure 5. Frequency Dependence of Responsivity

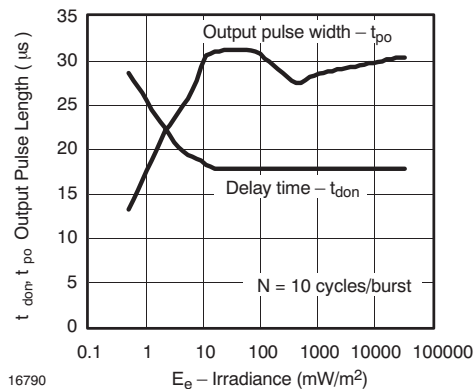

Figure 3. Output Pulse Diagram (t_{don}, t_{po})

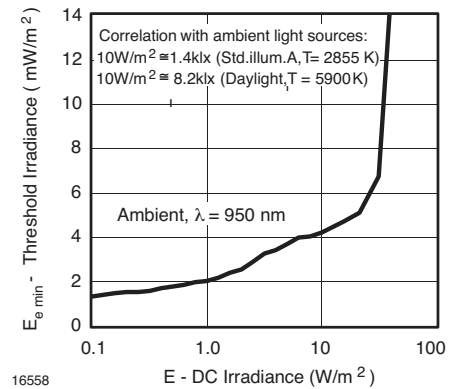

Figure 6. Sensitivity in Bright Ambient

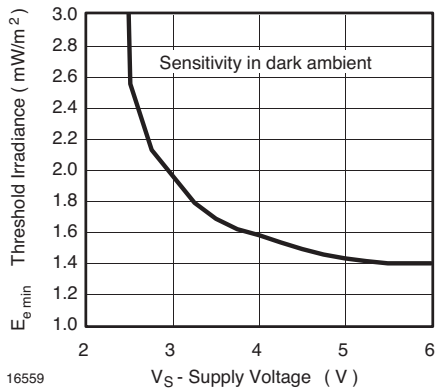

Figure 7. Sensitivity vs. Supply Voltage

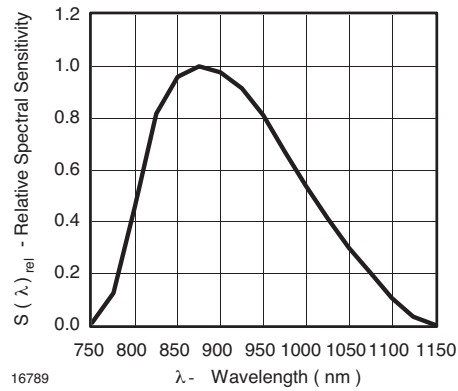

Figure 10. Relative Spectral Sensitivity vs. Wavelength

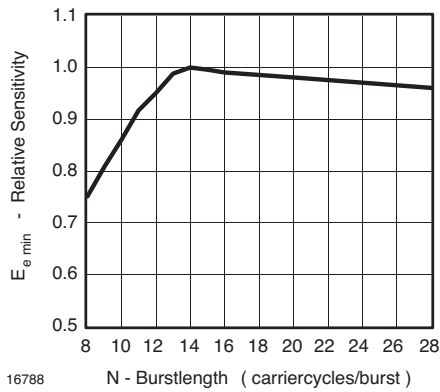

Figure 8. Rel. Sensitivity vs. Burstlength

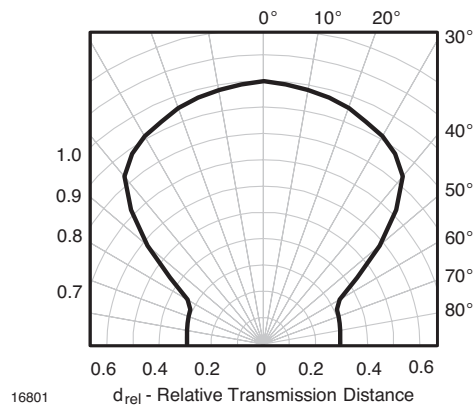

Figure 11. Directivity

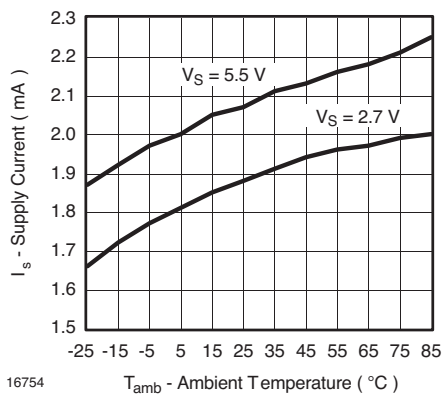

Figure 9. Supply Current vs. Ambient Temperature



Recommendation for Suitable Data Formats

The circuit of the TSOP5700 is designed in that way that disturbance signals are identified and unwanted output pulses due to noise or disturbances are avoided. A bandpass filter, an automatic gain control and an integrator stage is used to suppress such disturbances. The distinguishing marks between data signal and disturbance are carrier frequency, burst length and the envelope duty cycle.

The data signal should fulfill the following conditions:

- The carrier frequency should be close to 455 kHz.
- The burstlength should be at least 22 μs (10 cycles of the carrier signal) and shorter than 500 μs .
- The separation time between two consecutive bursts should be at least 26 μs .
- If the data bursts are longer than 500 μs then the envelope duty cycle is limited to 25 %
- The duty cycle of the carrier signal (455 kHz) may be between 50 % (1.1 μs pulses) and 10 % (0.2 μs pulses). The lower duty cycle may help to save battery power.

Package Dimensions in mm

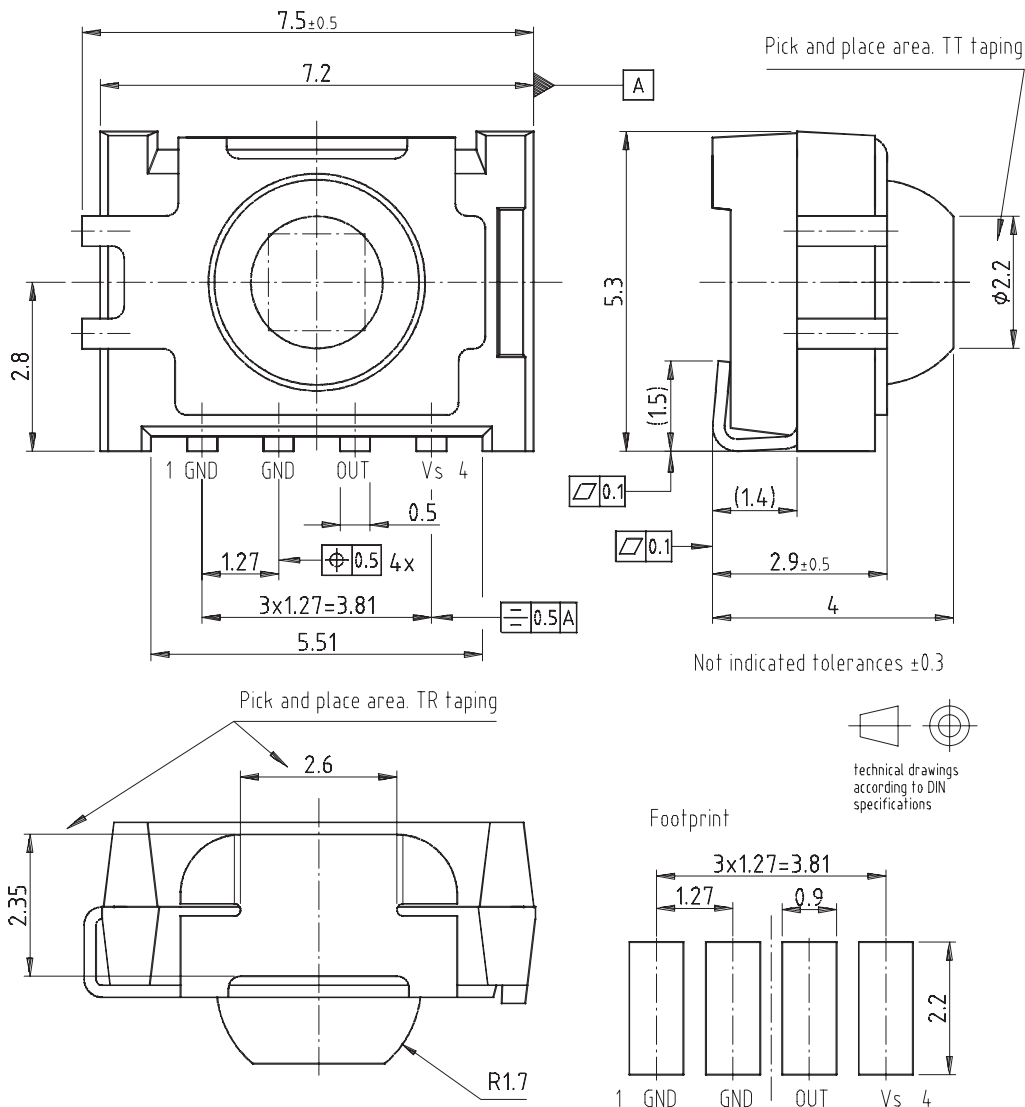

Drawing-No.: 6.544-5341.01-4
Issue: 5; 28.10.02

16776

Assembly Instructions

Reflow Soldering

- Reflow soldering must be done within 72 hours stored under max. 30°C , 60 % RH after opening envelop

- Recommended soldering paste (composition: SN 63 %, Pb 37 %) Melting temperature 178°C to 192°C
- Apply solder paste to the specified soldering pads, by using a dispenser or by screen printing.

- Recommended thickness of metal mask is 0.2 mm for screen printing.
- The recommended reflow furnace is a combination-type with upper and lower heaters.
- Set the furnace temperatures for pre-heating and heating in accordance with the reflow temperature profile as shown below. Exercise extreme care to keep the maximum temperature below 230 °C. The following temperature profile means the temperature at the device surface. Since temperature difference occurs between the work and the surface of the circuit board depending on the position of circuit board or reflow furnace, the operating conditions should be verified prior to start of operation.
- Handling after reflow should be done only after the work surface has been cooled off.

Reflow Solder Profile

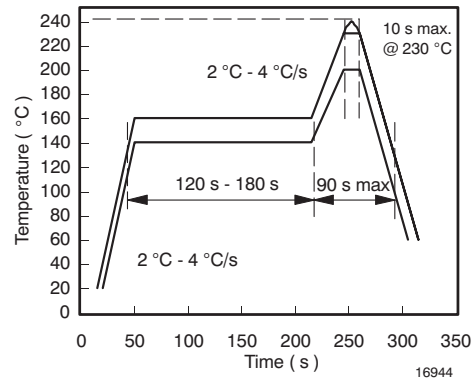

Manual Soldering

- Use the 6/4 solder or the solder containing silver.
- Use a soldering iron of 25 W or smaller. Adjust the temperature of the soldering iron below 300 °C.
- Finish soldering within three seconds.
- Handle products only after the temperature is cooled off.

Cleaning

- Perform cleaning after soldering strictly in conformance to the following conditions:

Cleaning agent:

2-propanol (isopropyl alcohol)

Commercially available grades (industrial use) should be used.

Demineralized or distilled water having a resistivity of not less than 500 mΩ corresponding to a conductivity of 2 mS/m.

- Temperature and time: 30 seconds under the temperature below 50 °C or 3 minutes below 30 °C.
- Ultrasonic cleaning: Below 20 W.

Taping Version TSOP..TT

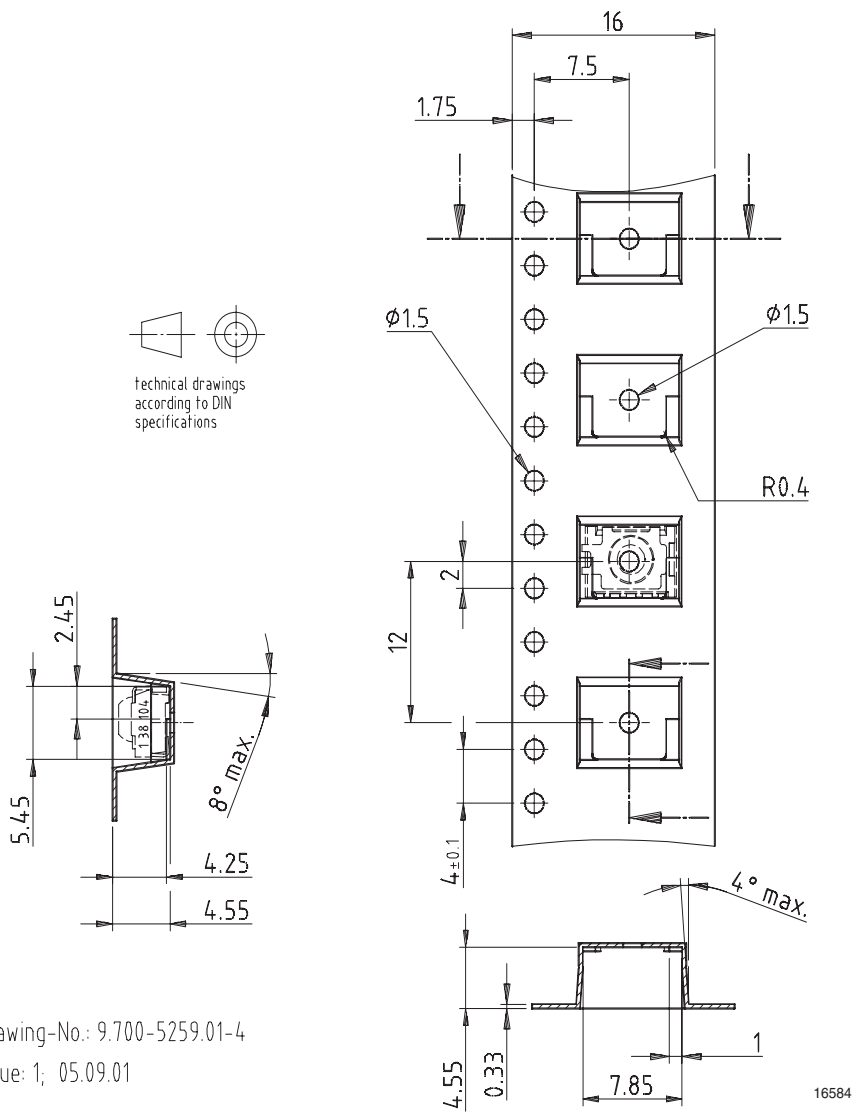

Drawing-No.: 9.700-5259.01-4
Issue: 1; 05.09.01

Taping Version TSOP..TR

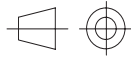

technical drawings
according to DIN
specifications

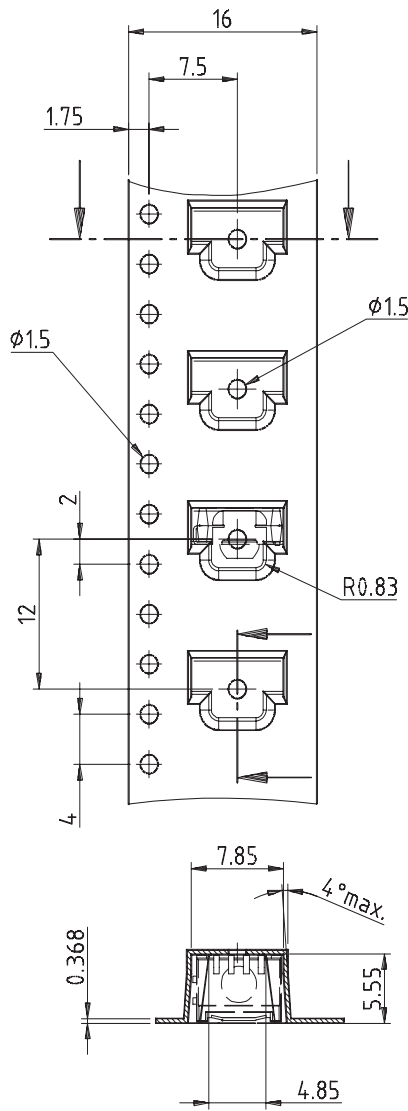
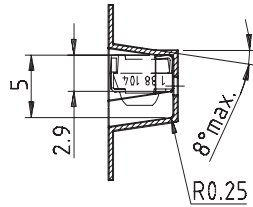

Drawing-No.: 9.700-5260.01-4

Issue: 2; 25.09.01

16585

Reel Dimensions

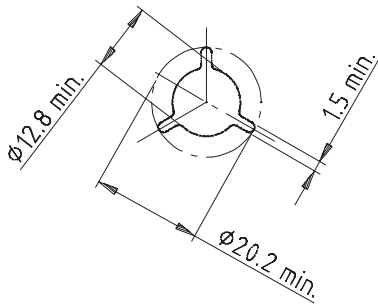
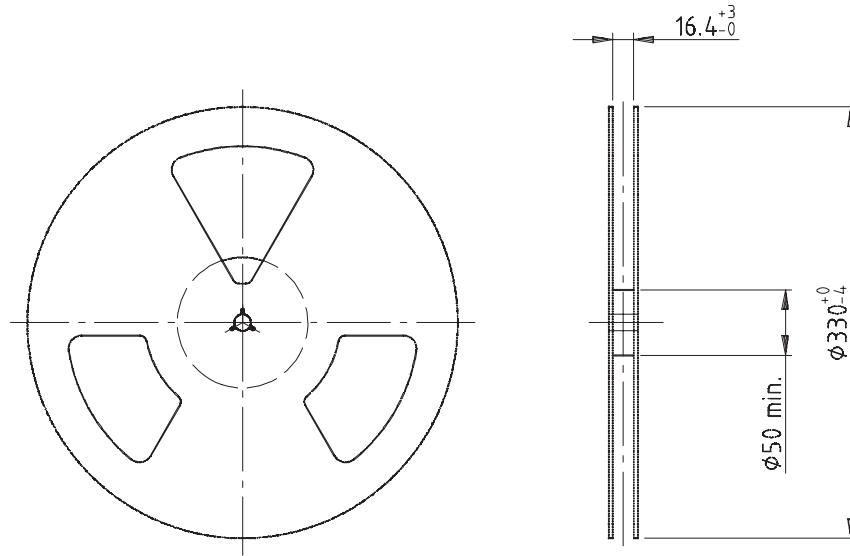

Reel hub 2:1

Form of the leave open of the wheel is supplier specific.

Dimension acc. to IEC EN 60 286-3

Tape width 16

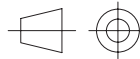

technical drawings according to DIN specifications

Drawing refers to following types: Reel for blister carrier tape Version B

16734

Drawing-No.: 9.800-5052.V2-4

Issue: 1; 07.05.02

Leader and Trailer

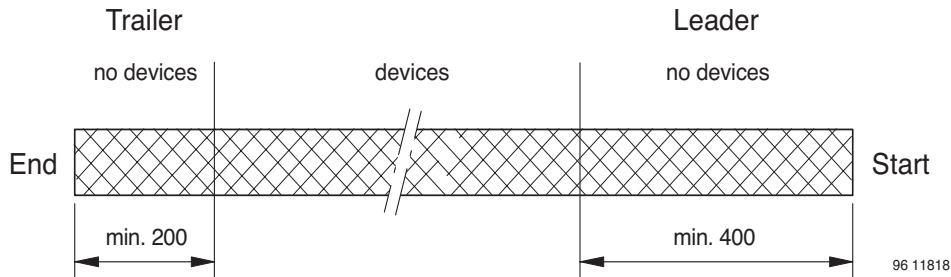

Cover Tape Peel Strength

According to DIN EN 60286-3

0.1 to 1.3 N

300 ± 10 mm/min

165 ° - 180 ° peel angle

Label

Standard bar code labels for finished goods

The standard bar code labels are product labels and used for identification of goods. The finished goods are packed in final packing area. The standard packing units are labeled with standard bar code labels before transported as finished goods to warehouses. The labels are on each packing unit and contain Vishay Semiconductor GmbH specific data.

Vishay Semiconductor GmbH standard bar code product label (finished goods)

Plain Writing	Abbreviation	Length
Item-Description	–	18
Item-Number	INO	8
Selection-Code	SEL	3
LOT-/ Serial-Number	BATCH	10
Data-Code	COD	3 (YWW)
Plant-Code	PTC	2
Quantity	QTY	8
Accepted by:	ACC	–
Packed by:	PCK	–
Mixed Code Indicator	MIXED CODE	–
Origin	xxxxxxx ⁺	Company Logo

Long Bar Code Top	Type	Length
Item-Number	N	8
Plant-Code	N	2
Sequence-Number	X	3
Quantity	N	8
Total Length	–	21

Short Bar Code Bottom	Type	Length
Selection-Code	X	3
Data-Code	N	3
Batch-Number	X	10
Filter	–	1
Total Length	–	17

16942

Dry Packing

The reel is packed in an anti-humidity bag to protect the devices from absorbing moisture during transportation and storage.

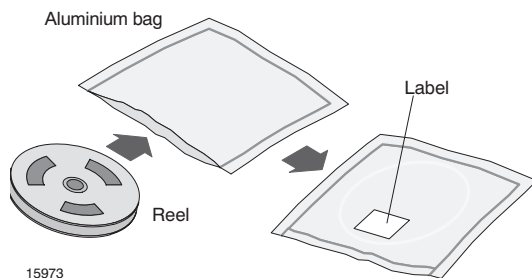

15973

Final Packing

The sealed reel is packed into a cardboard box. A secondary cardboard box is used for shipping purposes.

Recommended Method of Storage

Dry box storage is recommended as soon as the aluminium bag has been opened to prevent moisture absorption. The following conditions should be observed, if dry boxes are not available:

- Storage temperature 10 °C to 30 °C
- Storage humidity ≤ 60 % RH max.

After more than 72 hours under these conditions moisture content will be too high for reflow soldering. In case of moisture absorption, the devices will recover to the former condition by drying under the following condition:

192 hours at 40 °C + 5 °C/ -0 °C and < 5 % RH (dry air/ nitrogen) or

96 hours at 60 °C +5 °C and < 5 % RH for all device containers or

24 hours at 125 °C +5 °C not suitable for reel or tubes.

An EIA JEDEC Standard JESD22-A112 Level 4 label is included on all dry bags.

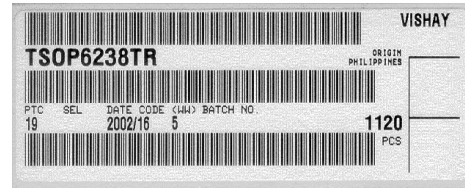

16962

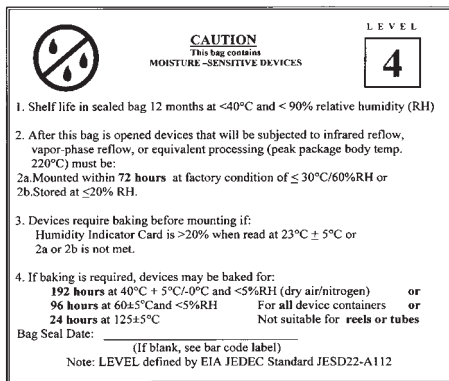

16943

Example of JESD22-A112 Level 4 label

ESD Precaution

Proper storage and handling procedures should be followed to prevent ESD damage to the devices especially when they are removed from the Antistatic Shielding Bag. Electro-Static Sensitive Devices warning labels are on the packaging.

Vishay Semiconductors Standard Bar-Code Labels

The Vishay Semiconductors standard bar-code labels are printed at final packing areas. The labels are on each packing unit and contain Vishay Telefunken specific data.

Ozone Depleting Substances Policy Statement

It is the policy of Vishay Semiconductor GmbH to

1. Meet all present and future national and international statutory requirements.
2. Regularly and continuously improve the performance of our products, processes, distribution and operating systems with respect to their impact on the health and safety of our employees and the public, as well as their impact on the environment.

It is particular concern to control or eliminate releases of those substances into the atmosphere which are known as ozone depleting substances (ODSs).

The Montreal Protocol (1987) and its London Amendments (1990) intend to severely restrict the use of ODSs and forbid their use within the next ten years. Various national and international initiatives are pressing for an earlier ban on these substances.

Vishay Semiconductor GmbH has been able to use its policy of continuous improvements to eliminate the use of ODSs listed in the following documents.

1. Annex A, B and list of transitional substances of the Montreal Protocol and the London Amendments respectively
2. Class I and II ozone depleting substances in the Clean Air Act Amendments of 1990 by the Environmental Protection Agency (EPA) in the USA
3. Council Decision 88/540/EEC and 91/690/EEC Annex A, B and C (transitional substances) respectively.

Vishay Semiconductor GmbH can certify that our semiconductors are not manufactured with ozone depleting substances and do not contain such substances.

We reserve the right to make changes to improve technical design
and may do so without further notice.

Parameters can vary in different applications. All operating parameters must be validated for each customer application by the customer. Should the buyer use Vishay Semiconductors products for any unintended or unauthorized application, the buyer shall indemnify Vishay Semiconductors against all claims, costs, damages, and expenses, arising out of, directly or indirectly, any claim of personal damage, injury or death associated with such unintended or unauthorized use.

Vishay Semiconductor GmbH, P.O.B. 3535, D-74025 Heilbronn, Germany
Telephone: 49 (0)7131 67 2831, Fax number: 49 (0)7131 67 2423